

Primera y más grande
planta de extrusión de
aluminio del Ecuador

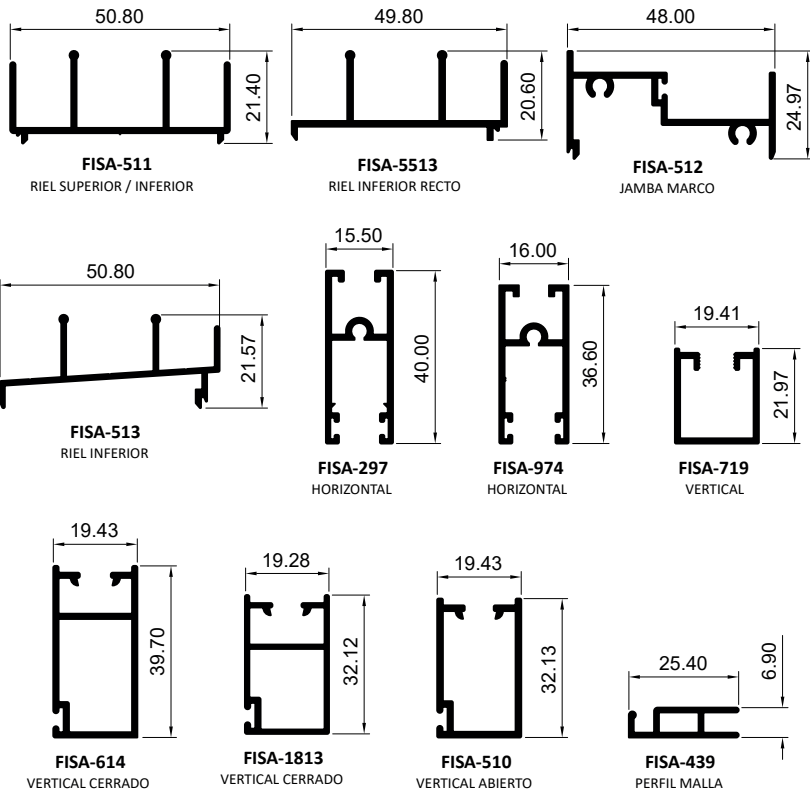

Km 10.5 Vía Daule,
Los Vergeles, Calle 23A No.
04-381-0460
ventas@fisa.com.ec
www.fisa.com.ec

VENTANA CORREDIZA DE 4 PERFILES



VENTANA CORREDIZA DE 7 PERFILES

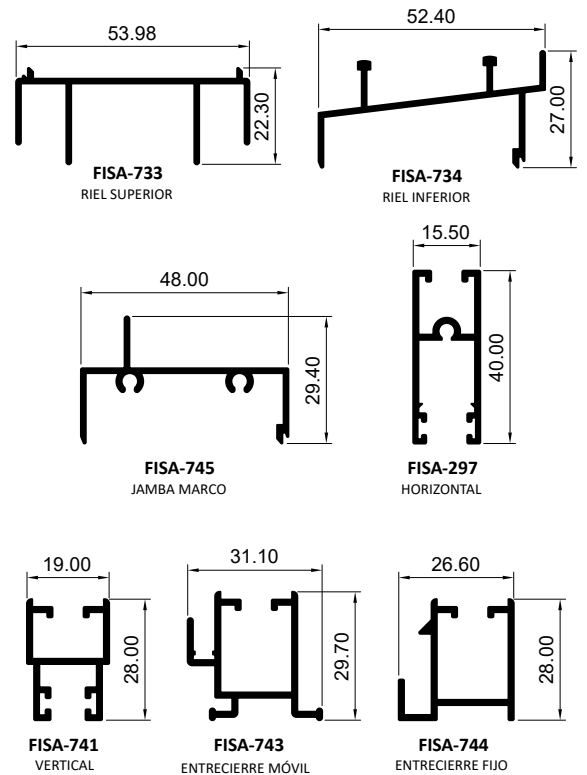

VENTANA FIJA

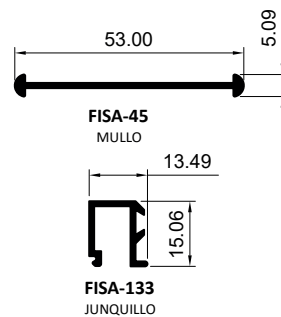
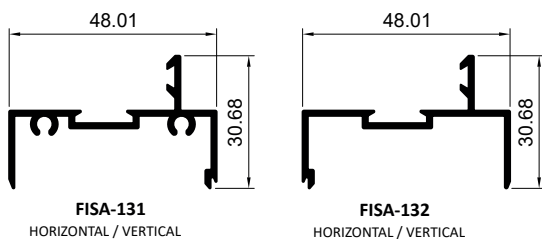

VENTANA FIJA ECONÓMICA

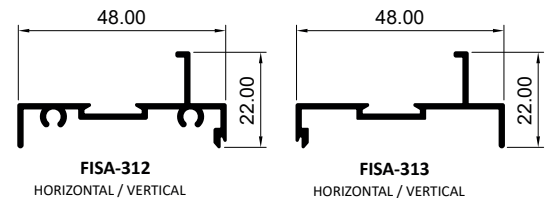

VENTANA PROYECTABLE

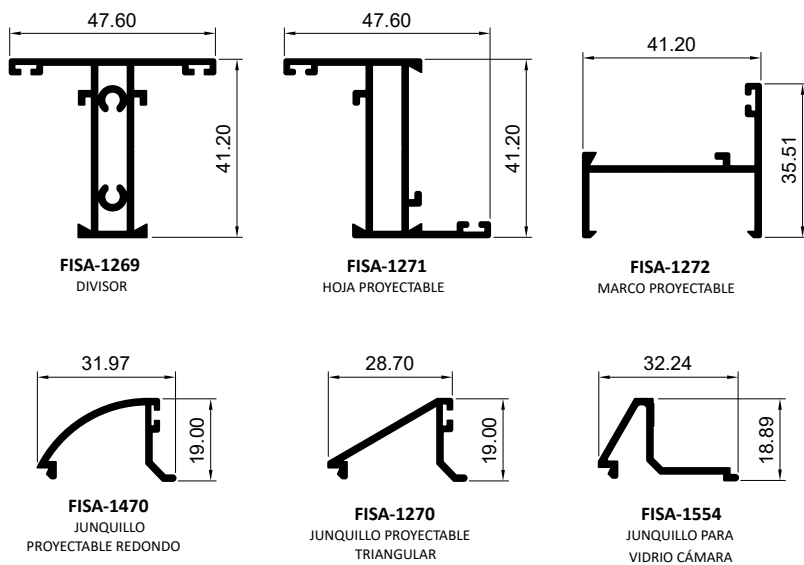

VENTANA CORREDIZA SÚPER ECONÓMICA

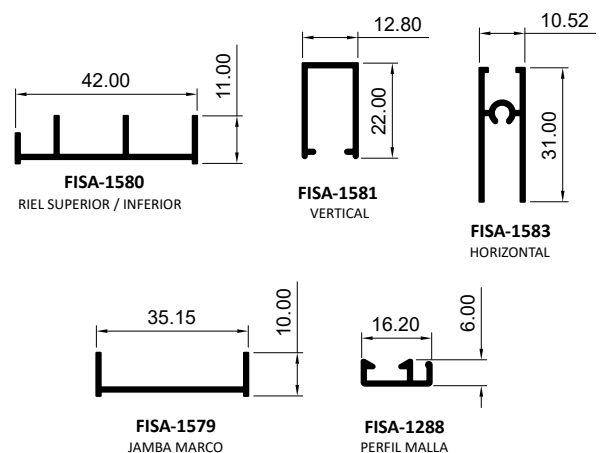

PUERTA CORREDIZA EUROPEA

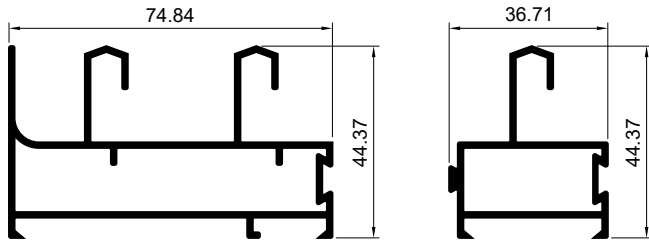

FISA-3445
MARCO 2 RIELES

FISA-3444
ADAPTADOR PARA
MARCO 3 RIELES

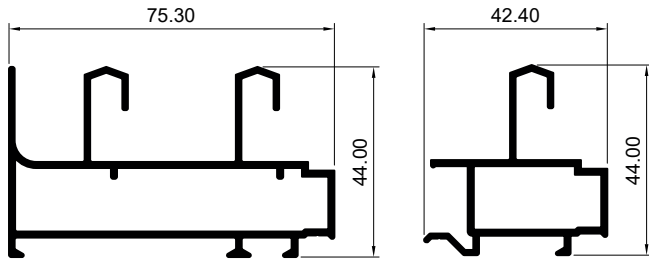

FISA-6445
MARCO 2 RIELES

FISA-6444
ADAPTADOR PARA
MARCO 3 RIELES

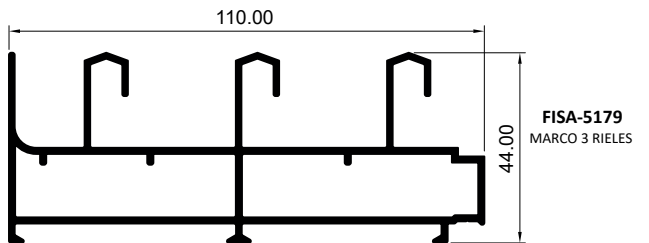

FISA-5179
MARCO 3 RIELES

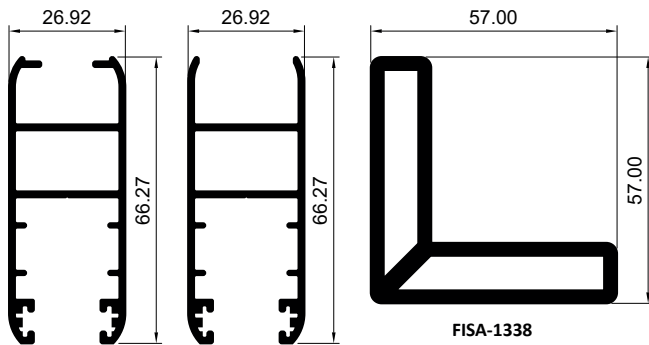

FISA-3446
HOJA

FISA-3606
HOJA VIDRIO CÁMARA

FISA-1338
ANCLA

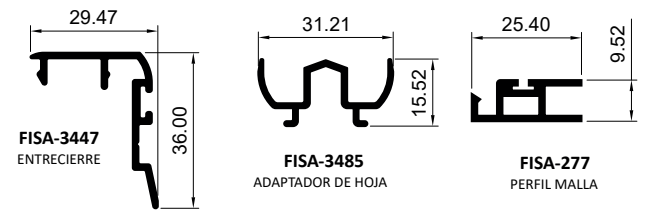

FISA-3447
ENTRECIERRE

FISA-3485
ADAPTADOR DE HOJA

FISA-277
PERFIL MALLA

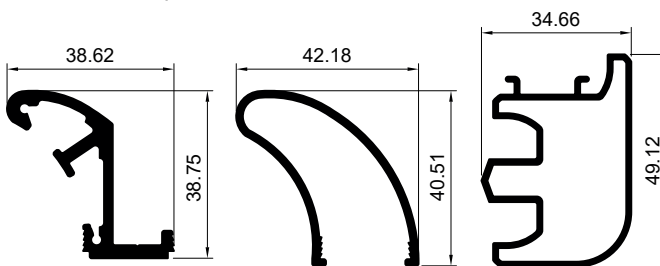

FISA-3670
ALMA TIRADERA

FISA-3671
TIRADERA

FISA-3512
ADAPTADOR ESQUINERO

VENTANA CORREDIZA EUROLIGHT

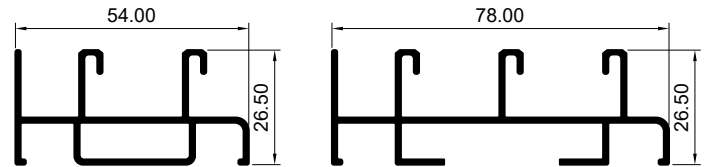

FISA-3880
MARCO 2 RIELES

FISA-4632
MARCO 3 RIELES

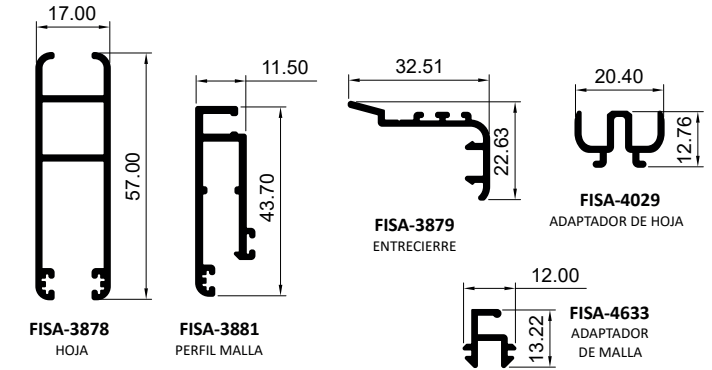

FISA-3878
HOJA

FISA-3881
PERFIL MALLA

FISA-3879
ENTRECIERRE

FISA-4029
ADAPTADOR DE HOJA

FISA-4633
ADAPTADOR
DE MALLA

SISTEMA ABATIBLE EUROPEO

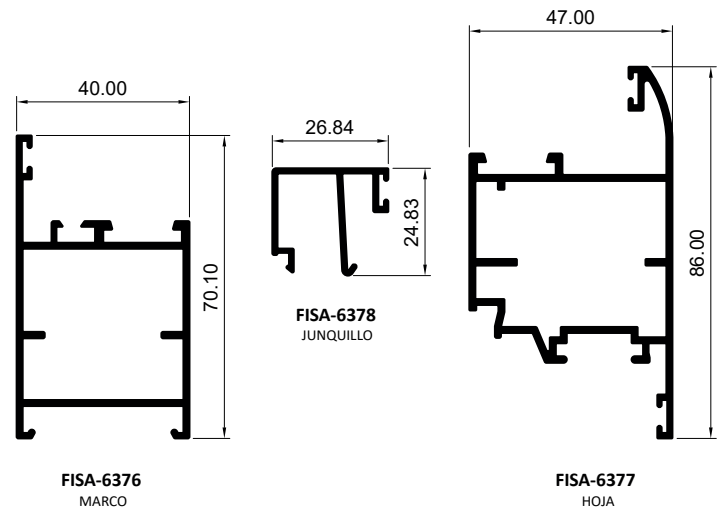

FISA-6376
MARCO

FISA-6378
JUNQUILLO

FISA-6377
HOJA

PUERTA BATIENTE

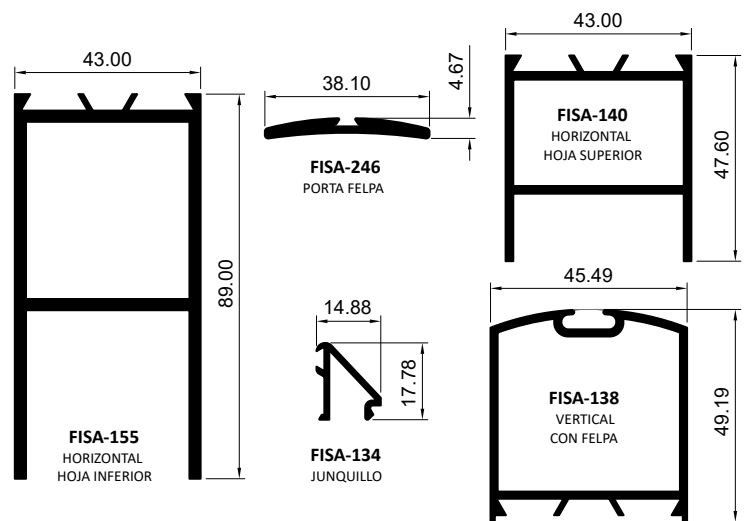

FISA-155
HORIZONTAL
HOJA INFERIOR

FISA-246
PORTA FELPA

FISA-140
HORIZONTAL
HOJA SUPERIOR

FISA-138
VERTICAL
CON FELPA

FISA-134
JUNQUILLO

PUERTA CORREDIZA ECONÓMICA

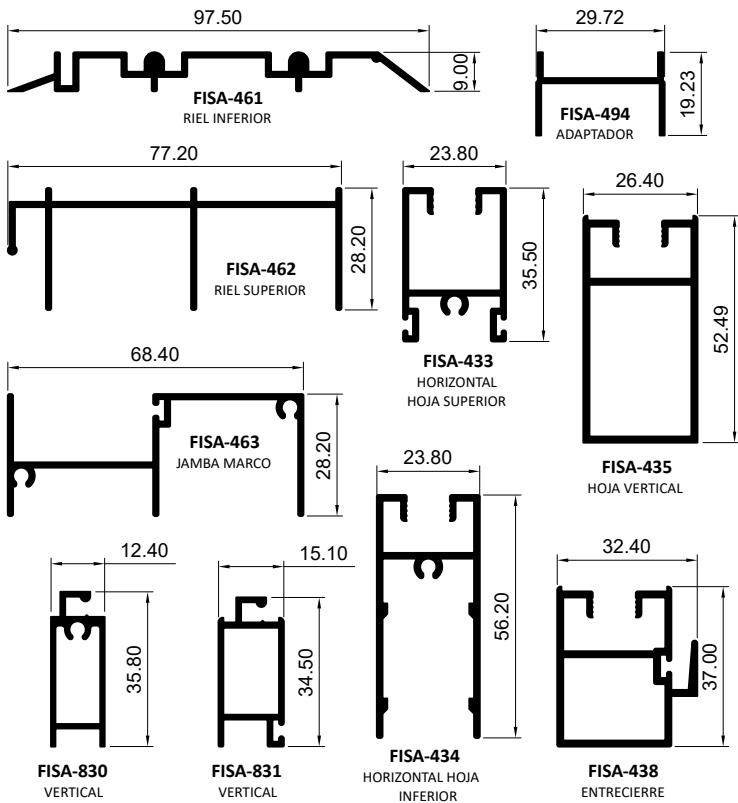

PUERTA DE BAÑO

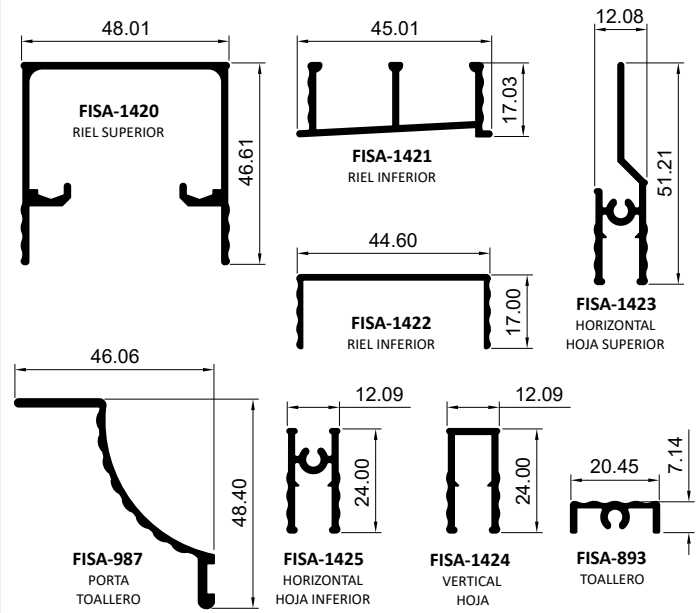

PUERTA CORREDIZA ESTÁNDAR

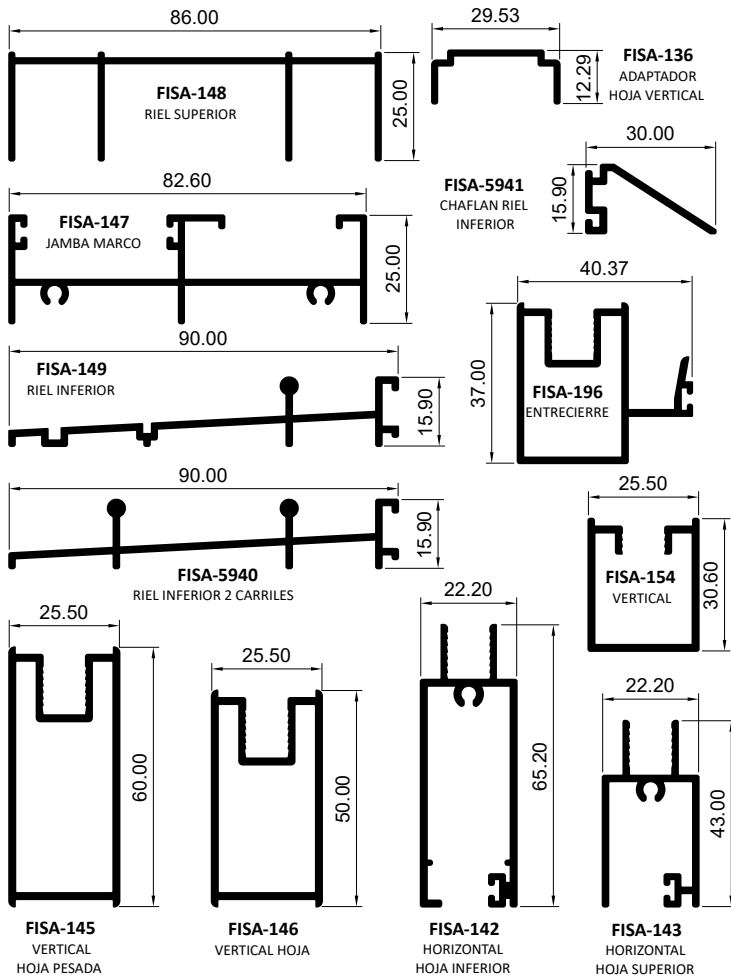

QUIEBRASOLES

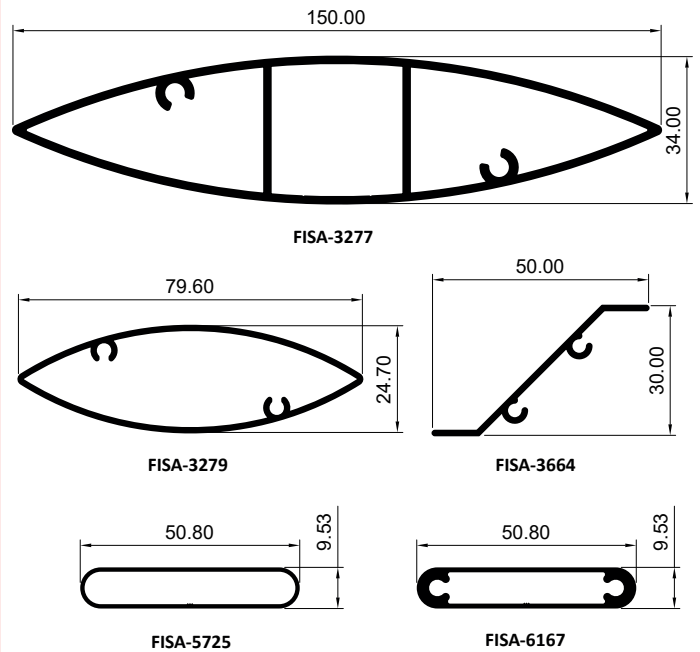

JUNQUILLOS PARA VIDRIO FIJO

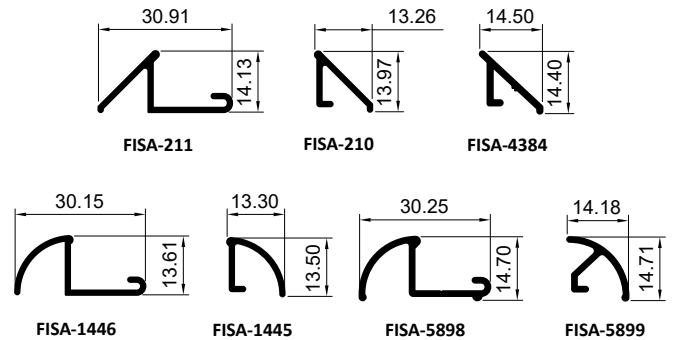

Código	L		e
	Milímetros	Pulgadas	Milímetros
FISA-1651	25,40	1	1,10
FISA-1591	31,75	1 1/4	1,12
FISA-1592	38,10	1 1/2	1,12
FISA-1366	50,80	2	1,40
FISA-20	50,80	2	3,17
FISA-2988	76,20	3	1,40
FISA-3562	76,20	3	2,36
FISA-2662	76,20	3	3,18
FISA-3230	101,60	4	3,18
FISA-5165	152,40	6	3,18
FISA-5957	152,40	6	4,34
FISA-3167	152,40	6	6,35

TUBOS CUADRADOS

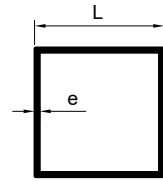

PLATINAS

Código	L		e
	Milímetros	Pulgadas	Milímetros
FISA-1558	31,50	1 1/4	1,75
FISA-244	37,97	1 1/2	3,00

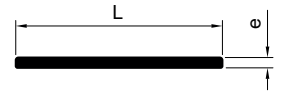

ÁNGULOS LADOS IGUALES

Código	L		e
	Milímetros	Pulgadas	Milímetros
FISA-369	25,00	0,984	1,02
FISA-1560	25,40	1	2,40
FISA-3260	31,80	1 1/4	3,18
FISA-12	38,10	1 1/2	3,10
FISA-8	50,80	2	3,18
FISA-472	50,80	2	6,00

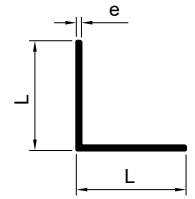

TUBOS RECTANGULARES

Código	L		H		e
	Milímetros	Pulgadas	Milímetros	Pulgadas	Milímetros
FISA-2469	38,10	1 1/2	19,05	3/4	1,15
FISA-1367	50,80	2	25,40	1	1,20
FISA-1368	50,80	2	38,10	1 1/2	1,20
FISA-1559	69,85	2 3/4	31,75	1 1/4	1,20
FISA-460	76,20	3	25,40	1	1,20
FISA-3779	76,20	3	25,40	1	1,30
FISA-1369	76,20	3	38,10	1 1/2	1,30
FISA-4879	101,60	4	38,10	1 1/2	1,40
FISA-899	101,60	4	38,10	1 1/2	1,80
FISA-374	101,60	4	44,50	1 3/4	1,50
FISA-3280	152,40	6	76,20	3	3,18
FISA-3340	152,40	6	76,20	3	6,35
FISA-2845	152,40	6	101,60	4	6,35

ÁNGULOS LADOS DESIGUALES

Código	L		H		e
	Milímetros	Pulgadas	Milímetros	Pulgadas	Milímetros
FISA-1623	25,40	1	12,70	1/2	1,00
FISA-1735	38,10	1 1/2	25,40	1	1,57
FISA-12	38,10	1 1/2	25,40	1	3,10
FISA-863	38,10	1 1/2	30,00	1,181	3,18
FISA-650	41,80	1 2/3	40,00	1,575	1,50
FISA-2612	50,80	2	25,40	1	3,18
FISA-4050	63,50	2 1/2	25,40	1	1,57

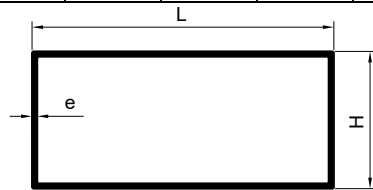
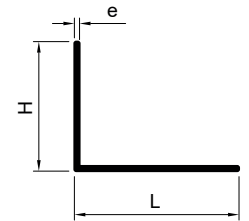

PERFILES U

Código	L		H		e
	Milímetros	Pulgadas	Milímetros	Pulgadas	Milímetros
FISA-11	25,40	1	12,70	1/2	1,15
FISA-946	82,55	3 1/4	25,40	1	2,21

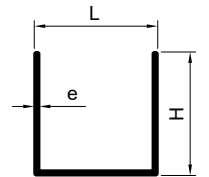

TUBOS CON TORNILLERO

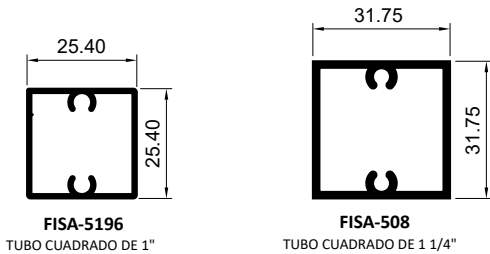

TUBOS VARIOS

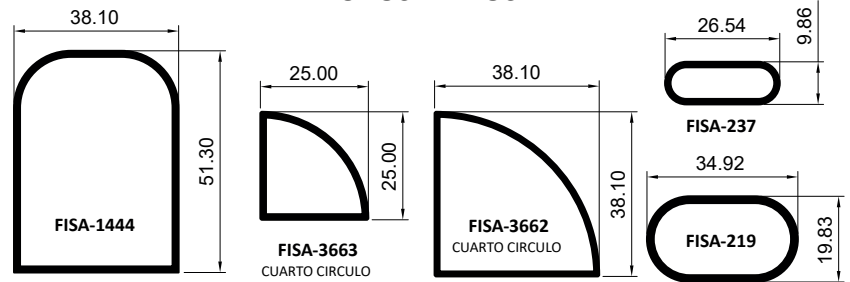

PERFILES VARIOS

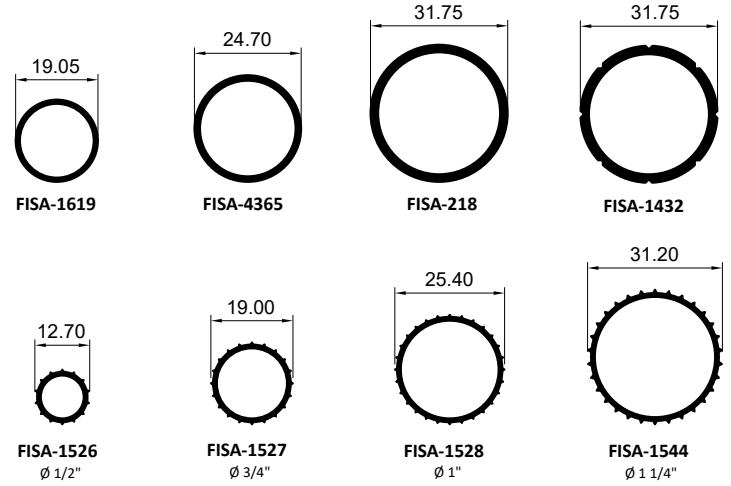
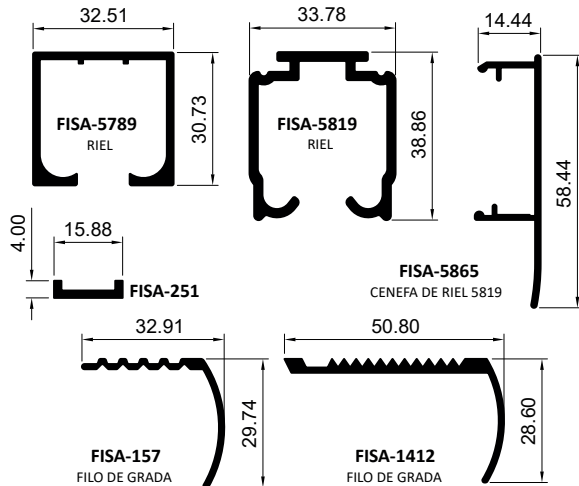

CANALES Y TUBOS CON ALETA/FELPERO

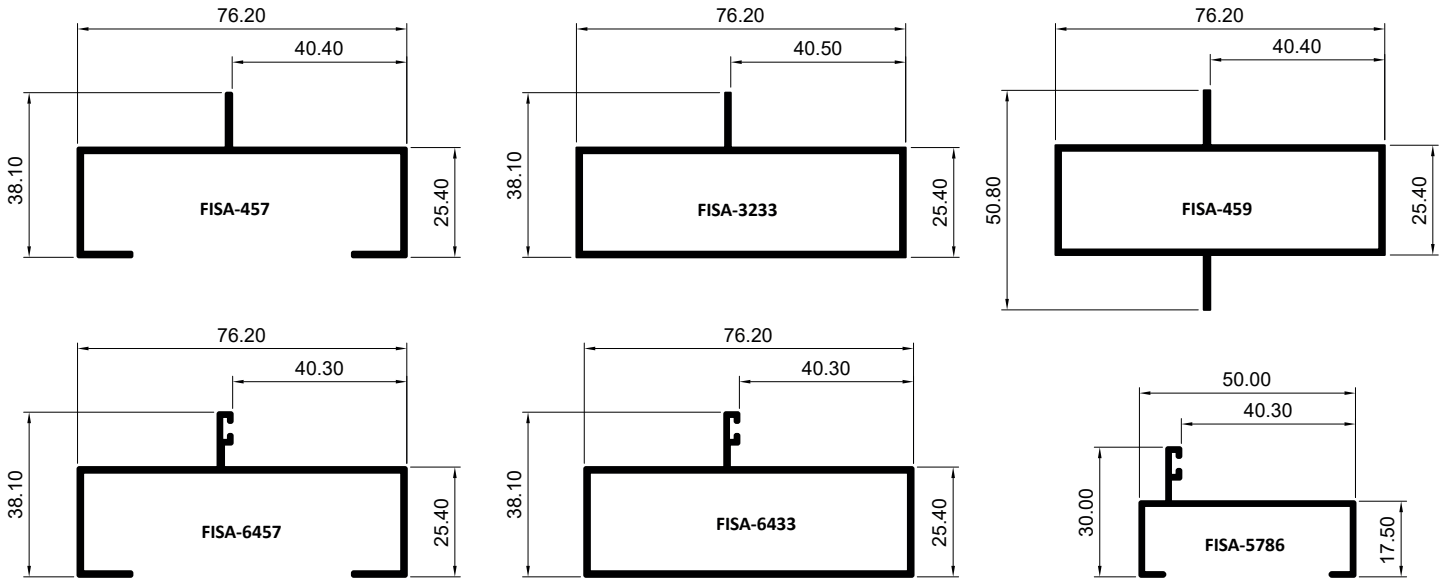

CANAL SIN ALETA

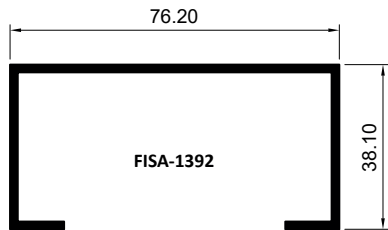

ALFAJIA

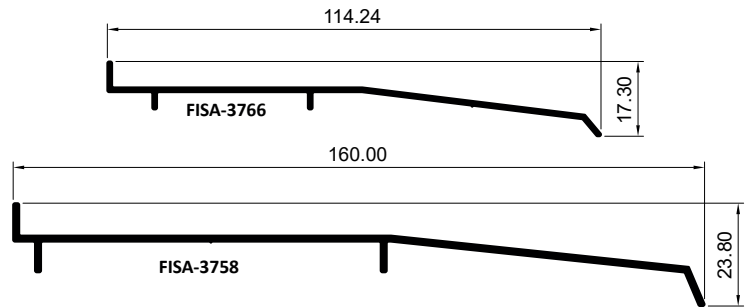

MAMPARA DE 2" x 1 1/2"

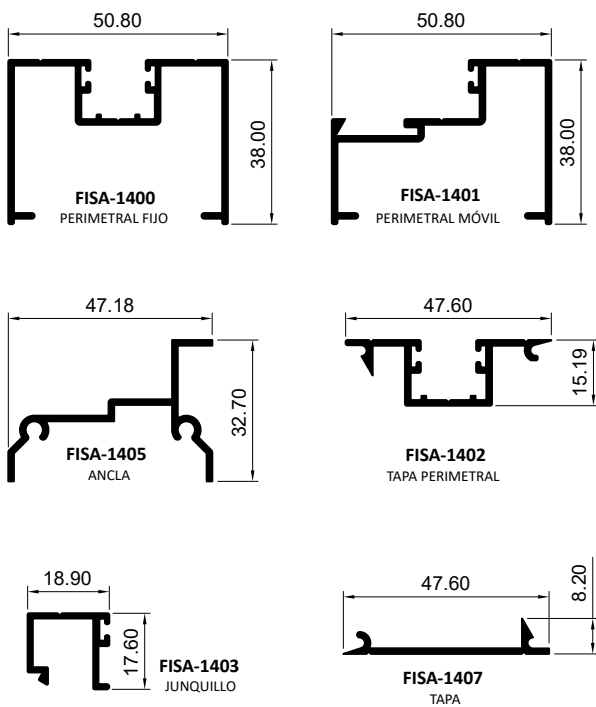

MAMPARA DE 3" x 1 1/2"

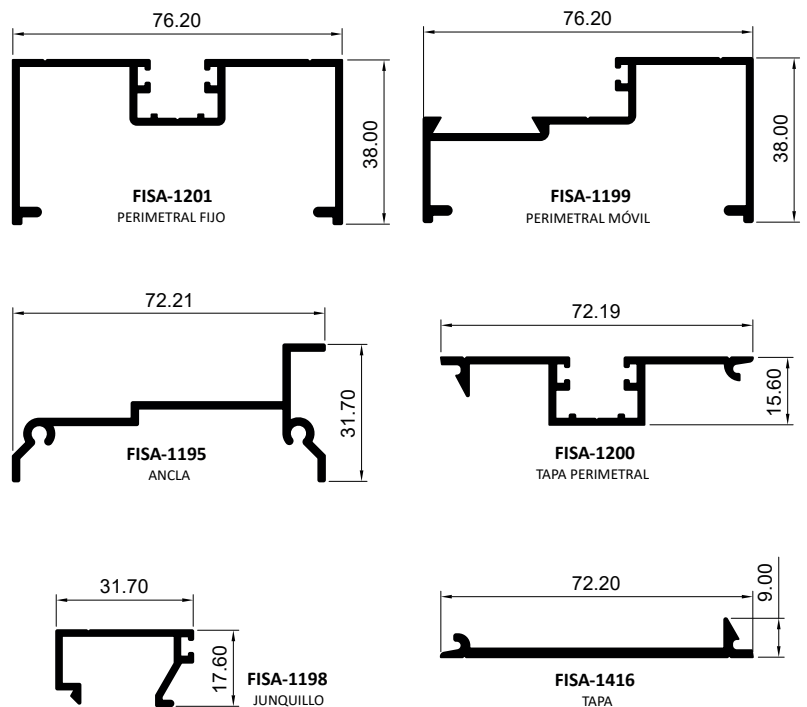

FACHADA FLOTANTE 1200

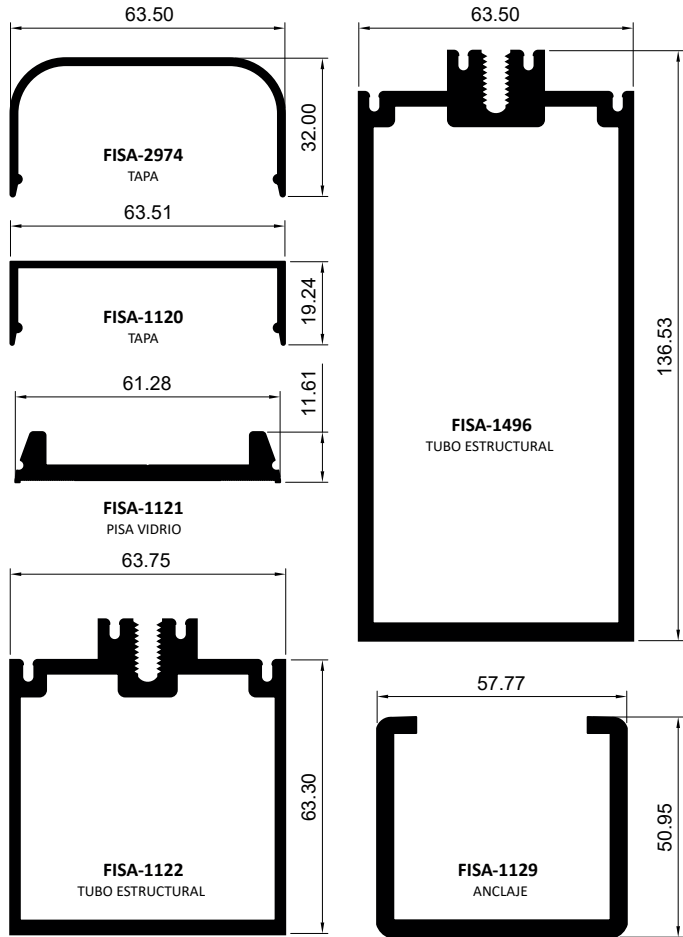

FACHADA FLOTANTE 1201

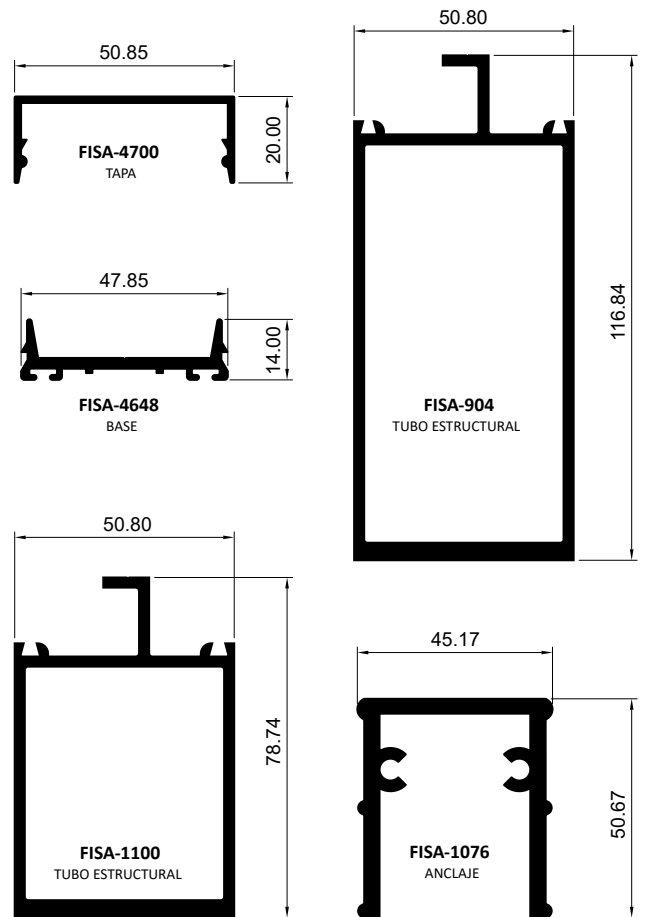

MAMPARA DE 4" x 1 3/4"

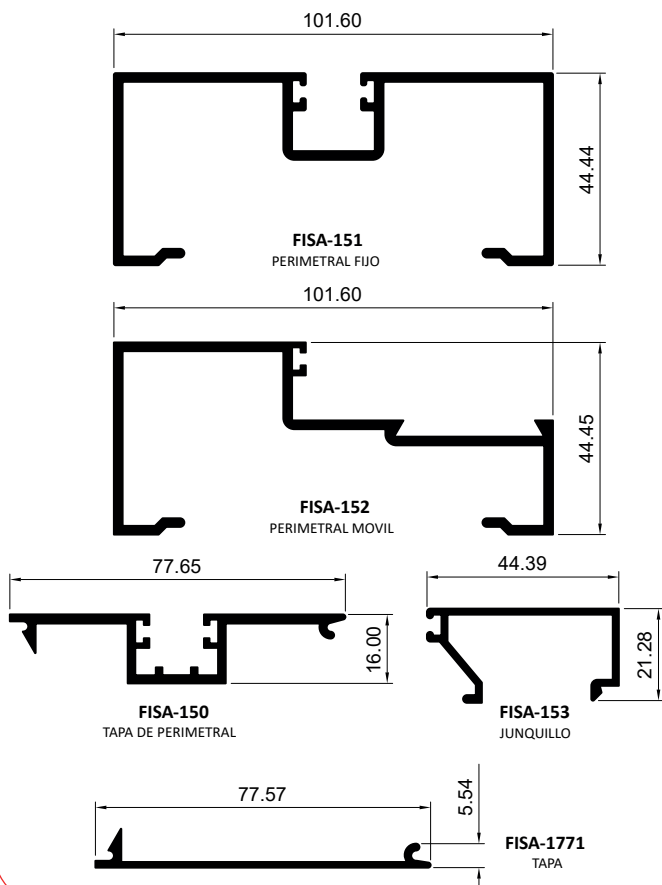

PIEL DE VIDRIO

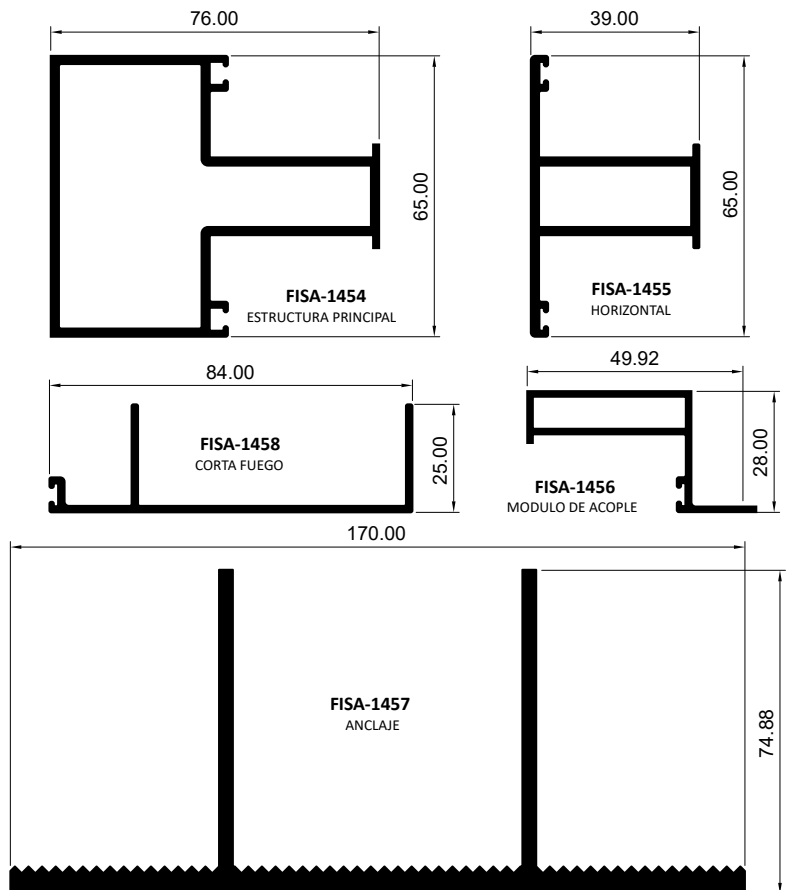

DIVISIONES MODULARES

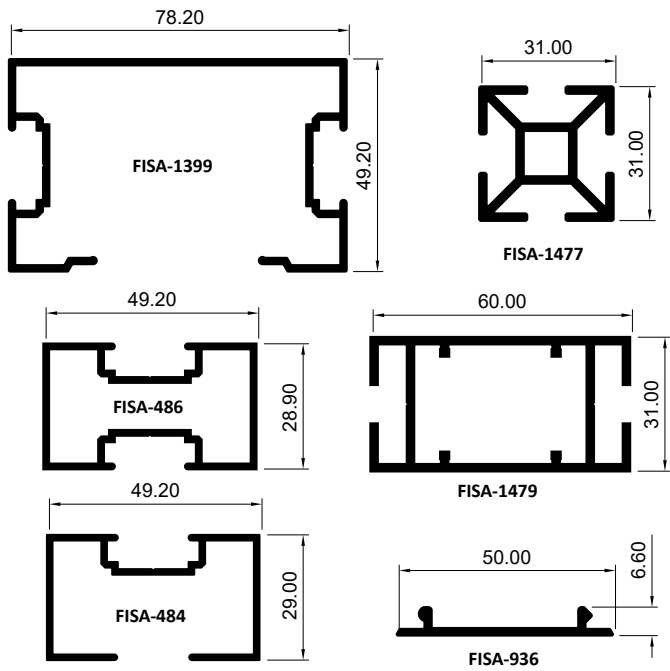

PASAMANOS

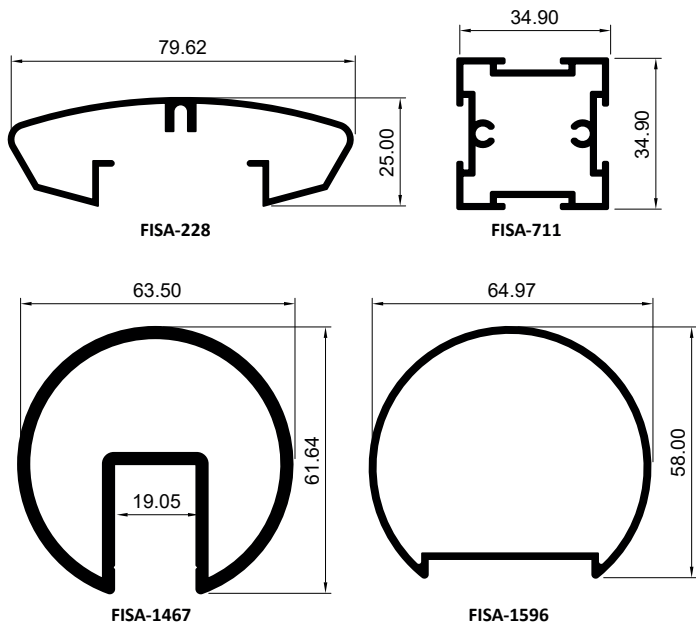

ZÓCALOS

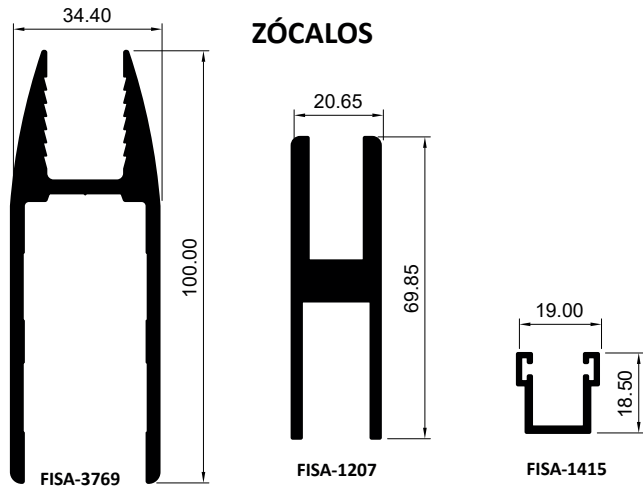

PERFILES DECORATIVOS

